

Rebling Datasheet: 250 amp Fixed-orientation SFT-style Feed-through Terminal

Some applications, especially automotive, require that a cable be attached to a terminal in a specific orientation. This terminal has orientation ridges that allow a cable lug to only be attached to the terminal perpendicular to the centerline of the mounting holes. A Fixed-orientation Terminal assures that a complex automotive cable harness, which might be 12 feet in length and have 20 different power and signal connectors attached, can only be installed on the vehicle in one orientation. The orientation ridges of this terminal are spaced 0.87" (22 mm) apart and are designed to accommodate standard ring lugs crimped to 1/0 or 2/0 (50 to 70 mm²) cable or narrow-tongue crimp lugs for 3/0 or 4/0 (80 to 110 mm²) cable. The nickel-plated brass conductor of this water-tight terminal has two blind M8 threaded holes which accept the stainless steel bolts and split washers included in the kit. The flexible cover and gasket which fit our standard SFT-style Terminal also fit this terminal.



Electrical

Current each current profile causes a max 30° C temperature rise when tested per IEC 61984

Current Profile #1	Continuous Rated Current (CRC)	-----	250 amps
Current Profile #2	50% CRC for 60min + 1 sec peak + 50% CRC for 60 min	-----	1,500 amps
Current Profile #3	50% CRC for 60min + 10 sec peak + 50% CRC for 60 min	-----	1,000 amps
Current Profile #4	50% CRC for 60min + 30 sec peak + 50% CRC for 60 min	-----	750 amps
Current Profile #5	50% CRC for 60min + 60 sec peak + 50% CRC for 60 min	-----	500 amps

Voltage & Resistance

Continuous Rated Voltage	UL1977 Section 17	2,000 volts
Minimum Dielectric Withstanding Voltage	UL1977 Section 17	5,000 volts
Insulation Resistance	MIL-PRF-18148D Section 3.12.6	500 mega-ohms
Maximum Contact Resistance	MIL-STD-202H Method 307	70 micro-ohms

Mechanical & Environmental

Flammability Rating:	Terminal -----	UL 94	V-0
	Flexible Cover -----	UL 94	V-0
Environmental Sealing:	with Optional Gasket -----	IEC 60529	IP68+ watertight
	without Optional Gasket -----	IEC 60529	IP65
Operating Temperature:	Terminal -----		-40 to +125 C
	Flexible Cover -----		-40 to +90 C
Mechanical Shock		MIL-STD-202H Method 213 Condition A	50 Gs – 3 axes
Vibration		MIL-STD-202H Method 204 Condition A	10 Gs – 3 axes
Minimum Panel Thickness Required for Mounting			0.025" (0.64 mm)
Maximum Wire Size:	Terminal only or with Flexible Cover -----		4/0 (110 mm ²)

Compliance & Conformance

RoHS, REACH, CMRT/3TG All parts listed on this datasheet are RoHS, REACH and CMRT/3TG Compliant
 UL and CE Conformance Declarations of UL and CE Conformity can be downloaded from Rebling.com

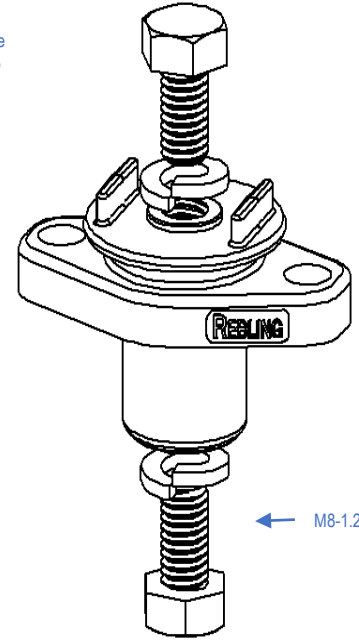
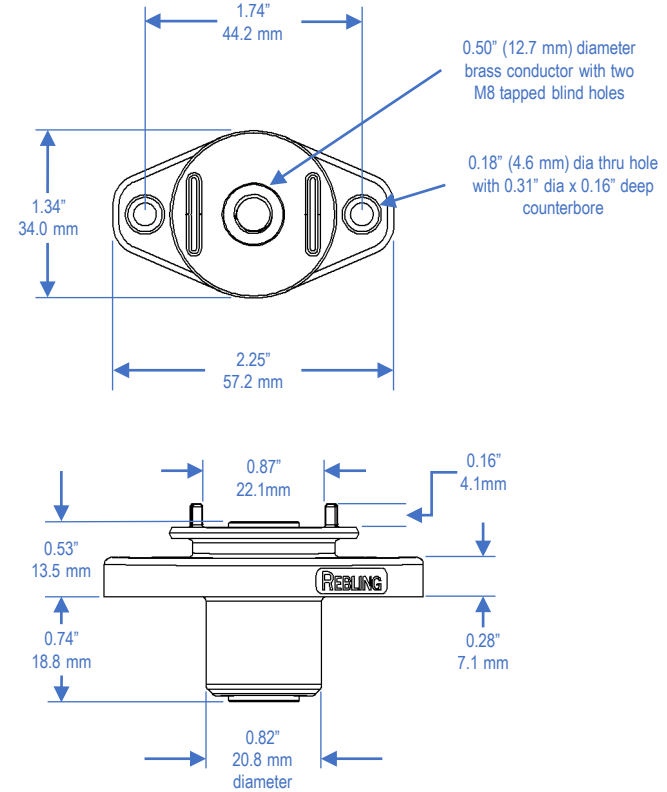

For complete dimensions, download 3D Step files of Terminal and Accessories at Rebling.com

Rebling Datasheet: 250 amp Fixed-orientation SFT-style Feed-through Terminal



P/N	Description	Plastic Color	Weight (Grams)	Min Thick (mm)	UL 94 Rating	UL Material Yellow Card # **
SFT-P-B-087	Terminal Kit*, Brass, Nickel plated	Black	75	2.1	V-0	E121562-220886
713A1806-B	Flexible Snap-On Cover (3.75" OAL, 0.82" ID)	Black	26	2.0	V-0	E80017-250533
SFT-P-R-087	Terminal Kit*, Brass, Nickel plated	Red	75	2.1	V-0	E121562-220886
713A1806-R	Flexible Snap-On Cover (3.75" OAL, 0.82" ID)	Red	26	2.0	V-0	E80017-250533
SFT-P-E-087	Terminal Kit*, Brass, Nickel plated	Blue	75	2.1	V-0	E121562-220886
713A1806-E	Flexible Snap-On Cover (3.75" OAL, 0.82" ID)	Blue	26	2.0	V-0	E80017-250533
716A1814	Gasket for SFT Terminal	Black	2.2	2.0	V-0	E80017-250535

*Terminal Kit = one Terminal + two Bolts + two Split Washers, all parts in a small poly bag
 **UL Material Yellow Cards can be downloaded from ULprospector.com



Rebling Datasheet: 250 amp Fixed-orientation SFT-style Feed-through Terminal

Mounting and Assembly

Minimum Panel Thickness	0.025" (0.64 mm)	
Mounting Hole Pattern (see diagram below)	Three Circular Holes	
Torque on M8 Bolts:		
Recommended	50 to 60 in-lbs (5.6-6.8 Nm)	electrical performance does not get better or worse above 50 in-lbs (5.6 Nm)
Maximum Recommended	240 in-lbs (27 Nm)	a Grade 4, M8 stainless bolt will snap at 330 in-lbs (37 Nm)
Torque on M4 panel mount screws		
Recommended	10 to 15 in-lbs (1.1 - 1.7 Nm)	mechanical performance does not improve above 10 in-lbs (1.1 Nm)
Maximum Recommended	22 in-lbs (2.5 Nm)	the terminal's mounting ear will begin to deform at 36 in-lbs (4.0 Nm)
Maximum Crimp Lug Tongue Width:		
with Flexible Cover	1.10" (28 mm)	
with Short Rigid Snap-on Cover	0.91" (23 mm)	
with Long Rigid Snap-on Cover	0.70" (18 mm)	

Application Notes

- Watertight is superior to IP68:** Rebling terminals are completely watertight to a depth of 20 meters which is superior to any IP Rating. The definitions of IP67, IP68 and IP69k per IEC 60529 state that "water may penetrate the seal but shall do no harm", a condition that is unacceptable to lithium battery designers.
- Interchangeability of 500 amp and 250 amp Terminals:** if you are uncertain whether your application needs a 250 amp or 500 amp terminal, cut your panel with the mounting hole pattern for the 500 amp MFT-style Terminal. This gives you the flexibility of choice. If a 250 amp SFT-style Terminal is mounted in the MFT Terminal's mounting holes, the SFT Terminal will achieve all of its performance parameters, including watertight sealing.
- Cable Pulling Lubricant:** when using 4/0 (110 mm²) cable with the flexible cover, crimp the lug to the cable then push the lug into the cover using lubricant
- Panel Mounting Hardware:** to achieve watertight sealing, the McMaster Carr P/Ns shown below can be used
 - 92855A416 M4 stainless socket head screw
 - 91828A231 M4 stainless nut
 - 9452K15 M4 O-Ring

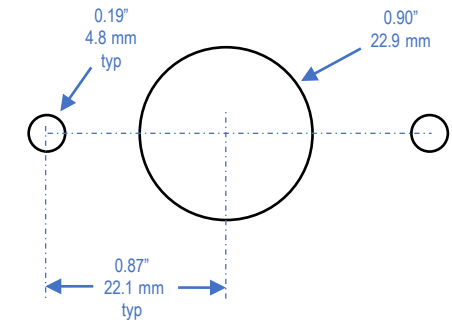
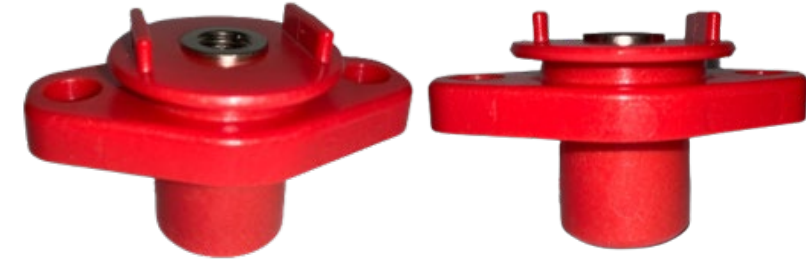

Mounting Hole Pattern